

SCR105

- temperature range $-50 \div 200^{\circ}\text{C}$
- operating temperature of connection heads max. 100°C
- stainless steel sheath
- MA type connection head
- possibility of mounting a 4...20 mA or 0...10 V temperature transmitter
- outer thermowell with process connection



Resistance thermometer **SCR105** consists of a non-exchangeable measuring insert, outer protective tube with threaded process connection (thermowell), and aluminum connection head. Miniature connection head MA type reduces the size of complete sensor construction to make possible installation in confined areas.

Application areas:

- fine chemical industry,
- light energy industry,
- general industrial services.

TECHNICAL DATA

Sensing element	Pt100, Pt500 or Pt1000 (2-, 3- or 4-wire)
Measuring range	$-50 \div 200^{\circ}\text{C}$
Connection head	MA, aluminum, operating temperature $-40 \div 100^{\circ}\text{C}$
Class	A, B or 1/3 B
Sheath	material: stainless steel 1.4541 or other nominal length: 100 mm (standard) or other diameter: 8 mm
Process connection	G1/2", M20x1,5 or other

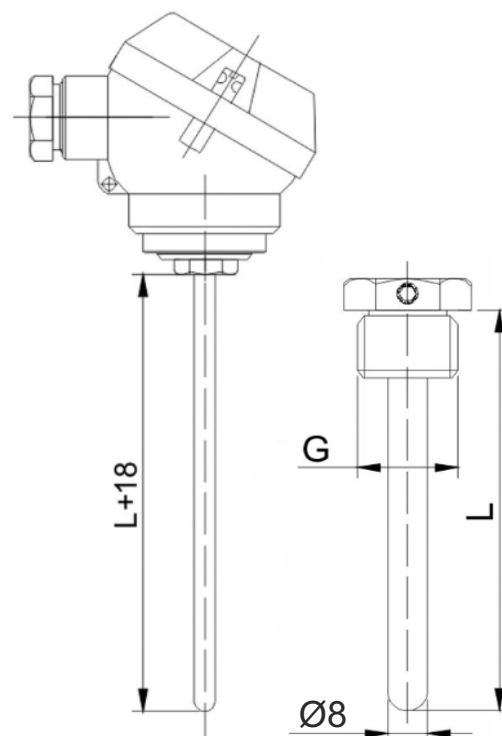

CONNECTION HEAD

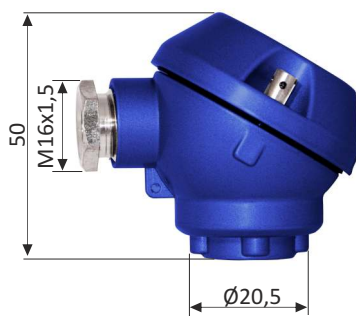

typ MA

RESISTOR TOLERANCE ACC. TO PN-EN 60751

Class	Tolerance [$^{\circ}\text{C}$]
1/3B	$t = 0,10 + 0,002 \times t $
A	$t = 0,15 + 0,002 \times t $
B	$t = 0,30 + 0,005 \times t $



ELECTRICAL CONNECTION

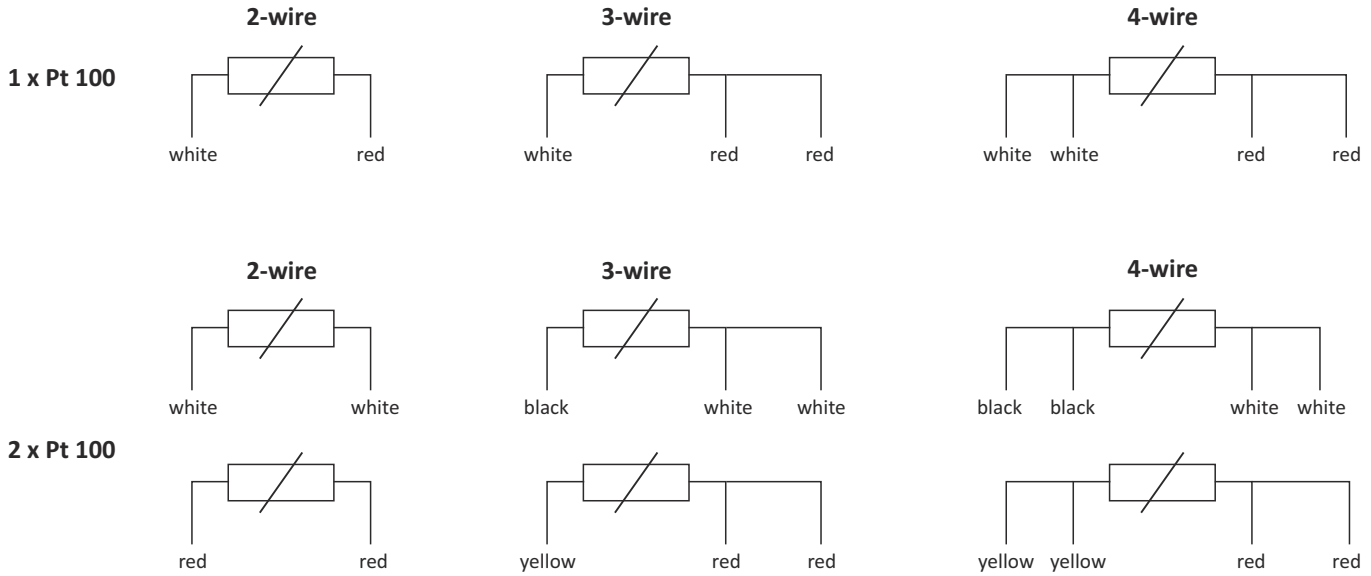

ORDERING

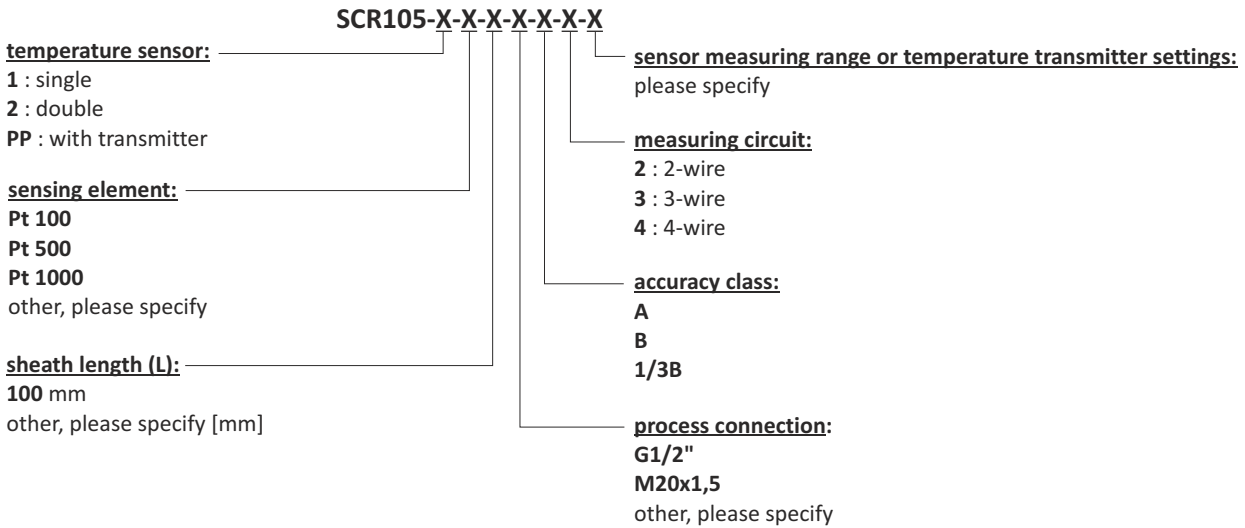

Ordering example:
SCR105-1-Pt100-100-G1/2"-B-2-100°C
 Single RTD temperature sensor, 1xPt100, B tolerance class, 2-wire, process connection: G1/2, sheath length L=100 mm, sensor measuring range 100°C.

