



# XMP i

## Precision Pressure Transmitter for the Process Industry with HART<sup>®</sup>-Communication and SIL2 (optionally)

Stainless Steel Sensor

accuracy according to EN IEC 62828-2:  
0.1 % span

### Nominal pressure

from 0 ... 400 mbar up to 0 ... 600 bar

### Output signals

2-wire: 4 ... 20 mA  
others on request

### Special characteristics

- ▶ turn-down 10:1
- ▶ two chamber aluminium die cast case or stainless field housing
- ▶ internal or flush welded diaphragm
- ▶ HART<sup>®</sup>-communication
- ▶ explosion protection, intrinsic safety(ia)

### Optional versions

- ▶ explosion protection, flameproof equipment (d)
- ▶ SIL 2 according to IEC 61508
- ▶ integrated display and operating module
- ▶ special materials as Hastelloy<sup>®</sup> and Tantalum
- ▶ cooling element for media temperatures up to 300 °C

The process pressure transmitter XMP i has been especially designed for the process industry as well as food and pharmaceutical industry (version stainless steel field housing) and measures vacuum, gauge and absolute pressure ranges of gases, steam, fluids up to 600 bar.

Different process connections such as threads and flanges with an internal or flush welded diaphragm are available and can be combined with a cooling element for media temperatures up to 300°C. The transmitter is as a standard equipped with HART<sup>®</sup>-communication; the customer can choose between a two chamber aluminium die cast case or a stainless field housing.

### Preferred areas of use are



Oil and gas industry / Chemical and petrochemical industry



Food / Pharmaceutical industry

### Material and test certificates

- ▶ material mill test report 3.1 according EN 10204



Pressure ranges <sup>1</sup>												
Nominal pressure gauge / abs. <sup>2,*</sup> [bar]	0.4	1	2	4	10	20	40	100	200	400	600	
Overpressure [bar]	2	5	10	20	40	80	105	210	600	1000	1000	
Burst pressure ≥ [bar]	3	7,5	15	25	50	120	210	420	1000	1250	1250	
<sup>1</sup> On customer request we adjust the devices within the turn-down-possibility by software to the required pressure ranges.												
<sup>2</sup> absolute pressure possible from 1 bar												
Vacuum ranges												
Nominal pressure gauge* [bar]	-0.4 ... 0.4		-1 ... 1		-1 ... 2		-1 ... 4		-1 ... 10			
Overpressure [bar]	2		5		10		20		40			
Burst pressure ≥ [bar]	3		7,5		15		25		50			
*for 0 ... 1 bar abs. or -1 ... 0 bar gauge max. temperature 70°C												
Output signal / Supply												
2-wire: 4 ... 20 mA With explosion protection	standard: intrinsic safety (ia) with HART®-communication options: flameproof equipment (d) with HART®-communication SIL2 / intrinsic safety (ia) with HART®-communication SIL2 / flameproof equipment (d) with HART®-communication								V <sub>S</sub> = 12 ... 28 V <sub>DC</sub> V <sub>S</sub> = 13 ... 28 V <sub>DC</sub> V <sub>S</sub> = 12 ... 28 V <sub>DC</sub> V <sub>S</sub> = 13 ... 28 V <sub>DC</sub>			
Current consumption	max. 25 mA											
Performance												
Accuracy <sup>3</sup> performance after turn-down (TD)	≤ ± 0.1 % span no change of accuracy the accuracy is calculated as follows: ≤ 0.1 + 0.015 x (turn-down - 5) % span e.g. turn-down 9: ≤ 0.1 + 0.015 x (9 - 5) % span = 0.16 % span											
- TD ≤ 5:1												
- TD > 5:1												
Permissible load	R <sub>max</sub> = [(V <sub>S</sub> - V <sub>Smin</sub> ) / 0.02 A] Ω					load during HART® communication: R <sub>min</sub> = 250 Ω						
Influence effects	supply: 0.05 % span / 10 V					permissible load: 0.05 % span / kΩ						
Long term stability	≤ ± 0.1 % span / year at reference conditions											
Response time	100 msec – without consideration of electronic damping						measuring rate 10/sec					
Adjustability	electronic damping: 0 ... 100 sec		offset 0 ... 90 % span;				turn-down of span up to 10:1					
<sup>3</sup> accuracy according to EN IEC 62828-2 – limit point adjustment (non-linearity, hysteresis, repeatability)												
Thermal errors / Permissible temperatures												
Tolerance band <sup>4,5</sup>	≤ 0.2 % span x turn-down (in compensated range -20 ... 85 °C)											
Permissible temperatures <sup>6</sup>	medium: -40 ... 125 °C for filling fluid silicon oil -10 ... 125 °C for filling fluid food compatible oil						without display: environment: -40 ... 80 °C storage: -40 ... 80 °C		with display: environment: -20 ... 70 °C storage: -30 ... 80 °C			
Permissible temperature medium for cooling element <sup>7</sup>	filling fluid silicon oil			overpressure: -40 ... 300 °C			low pressure: -40 ... 150 °C					
	filling fluid food compatible oil			overpressure: -10 ... 250 °C			low pressure: -10 ... 150 °C					
<sup>4</sup> an optional cooling element can influence thermal effects for offset and span depending on installation position and filling conditions												
<sup>5</sup> for flange- and DRD-version: tolerance band offset ≤ ± 1.6 % span / tolerance band span ≤ ± 0.6 % span												
<sup>6</sup> max. temperature of the medium for nominal pressure gauge > 0 bar: 150 °C for 60 minutes with a max. environmental temperature of 50 °C (without cooling element).												
<sup>7</sup> max. temperature depends on the used sealing material, type of seal and installation												
Electrical protection												
Short-circuit protection	permanent											
Reverse polarity protection	no damage, but also no function											
Electromagnetic compatibility	emission and immunity according to EN 61326											
Mechanical stability												
Vibration	5 g RMS (25 ... 2000 Hz)				according to DIN EN 60068-2-6							
Shock	100 g / 11 msec				according to DIN EN 60068-2-27							
Filling fluids												
Standard	silicon oil											
Options for process connections	food compatible oil with 21CFR178.3570 approval (Mobil SHC Cibus 32; Category Code: H1; NSF Registration No.: 141500) Halocarbon and others on request											
Materials												
Pressure port	stainless steel 1.4435 (316L)											
Housing	aluminium die cast, powder-coated or stainless steel 1.4404 (316L)											
Cable gland	brass, nickel plated											
Viewing glass	laminated safety glass											
Seals (media wetted)	thread: standard: FKM (recommended for medium temperatures ≤ 200 °C) option: FFKM (recommended for medium temperatures < 260 °C; (min. permissible temperature from -15 °C, possible for nominal pressure ranges P <sub>N</sub> ≤ 100 bar); others on request option: welded version for pressure ports according to EN 837 with P <sub>N</sub> between 1 and 40 bar DRD and flange: none, not included in the scope of delivery											
Diaphragm	standard: stainless steel 1.4435 (316 L)											

	options for process connections: Hastelloy® C-276 (2.4819), Tantalum (possible from 1 bar) on request	
Media wetted parts	pressure port, seal, diaphragm	
<b>Explosion protection</b>		
Approvals AX2-XMP i AX2-XMP I (with SIL2)	<b>Intrinsic safety</b> stainless steel field housing: zone 0: II 1G Ex ia IIC T4 Ga zone 20: II 1D Ex ia IIIC T85 °C Da $U_i = 28\text{ V}$ , $I_i = 98\text{ mA}$ , $P_i = 680\text{ mW}$ , $C_i = 0\text{ nF}$ , $L_i = 0\text{ }\mu\text{H}$ , $C_{\text{GND}} = 27\text{ nF}$	IBExU05ATEX1105 X (with SIL2: IBExU 05 ATEX1105 X) aluminium die cast case: zone 0/1: II 1/2G Ex ia IIB T4 Ga/Gb zone 20: II 1D Ex ia IIIC T85 °C Da $U_i = 28\text{ V}$ , $I_i = 98\text{ mA}$ , $P_i = 680\text{ mW}$ , $C_i = 0\text{ nF}$ , $L_i = 0\text{ }\mu\text{H}$ , $C_{\text{GND}} = 33\text{ nF}$
Approvals AX7-XMP i/AX7- XMP I (SIL2)	<b>flameproof enclosure</b> with aluminium die cast case IBExU12ATEX1073 X (with SIL2: IBExU 12 ATEX1073 X)/ zone 1: II 2G Ex db IIC T5 Gb	
Permissible temperatures for environment	in zone 0: -20 ... 60 °C with $p_{\text{atm}}$ 0.8 bar up to 1.1 bar zone 1 or higher: -40 ... 70 °C (intrinsically safe version); -20 ... 70 °C (flameproof enclosure)	
Connecting cables (by factory)	capacitance: signal line/shield also signal line/signal line: 160 pF/m inductance: signal line/shield also signal line/signal line: 1 $\mu\text{H}/\text{m}$	
<b>Miscellaneous</b>		
Option SIL 2 version	according to IEC 61508	
Safety Integrity Level	SIL2	
EHEDG certificate Type EL Class I	EHEDG conformity is only ensured in combination with an approved seal. This is e.g. for - Clamp (C61, C62, C63): T-ring-seal from Combifit International B.V. - Varivent (P41): EPDM-O-ring which is FDA-listed	
Display (optionally)	LC-display, visible range 32.5 x 22.5 mm; 5-digit 7-segment main display, digit height 8 mm, range of indication $\pm 9999$ ; 8-digit 14-segment additional display, digit height 5 mm; 52-segment bargraph; accuracy 0.1% $\pm$ 1 digit	
Ingress protection	IP 67	
Installation position	any (standard calibration in a vertical position with the pressure port connection down; differing installation position have to be specified in the order)	
Surface roughness	pressure port $R_a < 0.8\text{ }\mu\text{m}$ (media wetted parts); diaphragm $R_a < 0.15\text{ }\mu\text{m}$ weld seam $R_a < 0.8\text{ }\mu\text{m}$	
Weight	min. 400 g (depending on housing and mechanical connection)	
Operational life	$> 100 \times 10^6$ pressure cycles	
CE-conformity	EMC Directive: 2014/30/EU Pressure Equipment Directive: 2014/68/EU (module A) <sup>8</sup>	
ATEX Directive	2014/34/EU	

<sup>8</sup> This directive is only valid for devices with maximum permissible overpressure > 200 bar

**Wiring diagram**

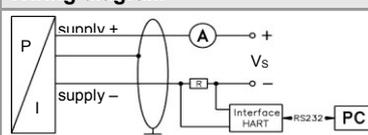

**Pin configuration**

Electrical connections	aluminium die cast case: terminal clamps (clamp section: 2.5 mm <sup>2</sup> )	stainless steel field housing: terminal clamps (clamp section: 1.5 mm <sup>2</sup> )
Supply +	IN+	IN+
Supply -	IN-	IN-
Test	Test	-
Shield	$\perp$	$\perp$



**Process connections for low pressure- max. to 40 bar (dimensions in mm)**

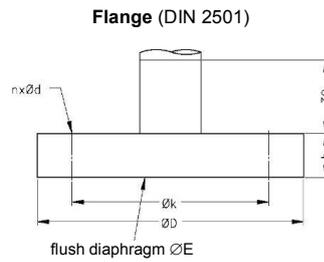
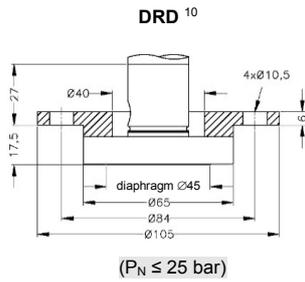

dimensions in mm			
size	DN25	DN50	DN80
D	115	165	200
E	30	89	89
k	85	125	160
b	18	20	20
n	4	4	8
d	14	18	18
PN [bar]	≤ 40	≤ 40	≤ 16

**Cooling element 7**

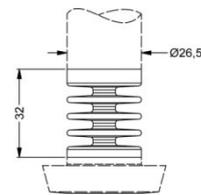

temperature range	300° C
-------------------	--------

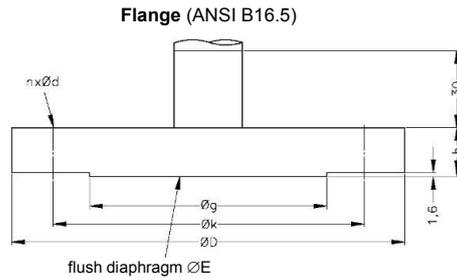

dimensions in mm		
size	2"/150 lbs	3"/150 lbs
D	152.4	190.5
E	86	89
g	91.9	127
k	120.7	152.4
b	19.1	23.9
n	4	4
d	19.1	19.1
PN [bar]	≤ 10	≤ 10

**Clamp (DIN 32676)**

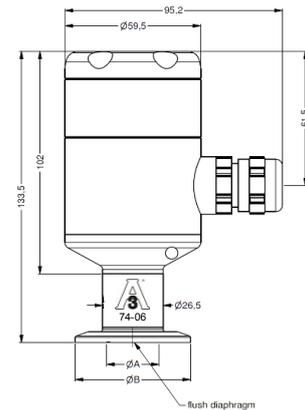

dimensions in mm				
size	1/4"	DN25	DN32	DN50
A	14	23	32	45
B	25	50.5	50.5	64
PN [bar]	≥ 4 ≤ 8	≥ 0,25 ≤ 16	≤ 16	≤ 16

**Varivent® (DN 40/50)**

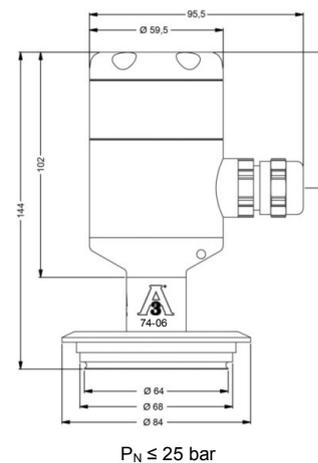

7 max. temperature depends on the used sealing material, type of seal and installation

10 Mounting flange is included in the delivery (already pre-assembled)

HART® is a registered trade mark of HART Communication Foundation; Hastelloy® is a brand name of Haynes International Inc.

Windows® is a registered trade mark of Microsoft Corporation

**Accessories for aluminium cast (not a part of delivery)**

Electrical connection Ex i (standard)		Electrical connection Ex d (flameproof enclosure)	
Ordering type	Ordering code	Ordering type	Ordering code
plug thread M20x1.5	1001871	plug thread M20x1.5	1001438
cable gland thread M20x1,5	1001460	cable gland thread M20x1,5	1001870

### Universal holder

Weight	cca 1 kg
Material	0308 (E235)
Surface finish	BIS UltraProtect 1000
Ordering code	5020043



### Dimensions (in mm)

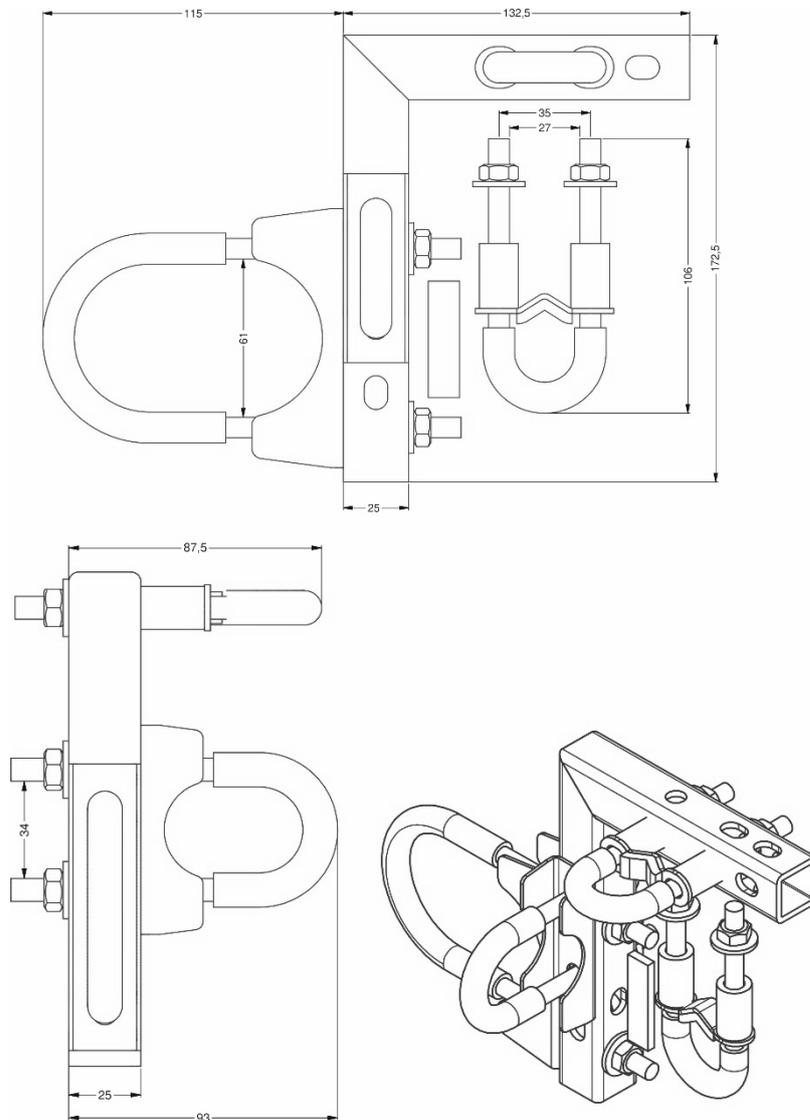



M 22 x 1,5 DIN 3852 flush (P <sub>N</sub> > 2,5 bar) (only with seals)	D	1	5						
Flange DN 25/PN 40 DIN 2501 (without seals)	F	2	0						
Flange DN 40/PN 40 DIN 2501 (without seals)	F	2	2						
Flange DN 50/PN 40 DIN 2501 (without seals)	F	2	3						
Flange DN 80/PN 16 DIN 2501 (without seals)	F	1	4						
Flange DN 100/PN 16 DIN 2501 (without seals)	F	2	5						
Varivent® DN 40/50 (without seals)	P	4	1						
Customer	9	9	9						
<b>Diaphragm</b>									
Stainless steel 1.4435 (316 L)				1					
Hastelloy® C-276 (2.4819) <sup>4</sup>				H					
Tantalum <sup>4,5</sup>				T					
Customer				9					
<b>Seals (included only in thread type connections)</b>									
Without seals (Clamp, dairy pipe DIN, sandwich, flange, varivent)					0				
Viton (FKM)					1				
EPDM					3				
FFKM (for media temperature ≤ 200 °C) <sup>6</sup>					7				
Without seals - welded (only with EN 837) <sup>7,8</sup>					2				
Customer					9				
<b>Filling Fluids</b>									
Silicone oil					1				
Food compatible oil (temperature max. 150 °C) <sup>4</sup>					2				
Halocarbon <sup>4</sup>					C				
Customer					9				
<b>Special version</b>									
Standard							0	0	0
With cooling element from 125 °C up to 150 °C							1	5	0
With cooling element from 150 °C up to 300 °C (P <sub>N</sub> ≤ 70 bar max. 200 °C permanent) <sup>4</sup>							2	0	0
Customer							9	9	9

3.1 Material Certificate for Membrane and Mechanical Connection  
 Settings in temperature different from basic 20 °C (+/- 10 °C, max. 70 bar and 200 °C)

<b>Diaphragm Seal</b>									
The price of the mechanical connection from above									
Capillary tube (price for 1m)									
<b>Flange with integral extended diaphragm</b>									
The price of the mechanical connection form above									
Extension length up to 100 mm									
Extension length between 100 - 200 mm									
<b>Accessories for Aluminium housing</b>									
<b>Electrical connection Ex ia (standard)</b>									
Blind flange Ex ia (M20x1,5 thread)									1001871
Cable gland Ex ia (M20x1,5 thread)									1001460
<b>Electrical connection Ex D (standard)</b>									
Blind flange Ex D (M20x1,5 thread)									1001438
Cable gland Ex D (M20x1,5 thread)									1001870
<b>Mounting Bracket</b>									
Universal holder (for pipes $\varnothing \leq 26,5$ mm)									5020043

0,...without additional charge  
 On request...in accordance with the producer

!!! When you make an order it is necessary to fill the questionnaire for transmitters with separators!!!  
 Surcharges for calibration are not subject to any discounts. Subject to change. □  
 This document contains the specification for ordering the product; detailed technical parameters of the product and its possible variants are given in the data sheet.  
 BD SENSORS reserves the right to change sensor specifications without further notice.

- if setting range shall be different from nominal range please specify in your order**
- 1 absolute pressure possible from 1 bar
  - 2 only possible in combination with aluminium die cast case
  - 3 only possible for P<sub>N</sub> ≥ 1 bar up to 40 bar
  - 4 only possible with process connections
  - 5 tantal diaphragm possible with nominal pressure ranges from 1 bar
  - 6 min. permissible temperature from -15 °C, possible for nominal pressure ranges P<sub>N</sub> ≤ 100 bar
  - 7 only for PN ≤ 40 bar
  - 8 welded version only with pressure ports according to EN 837



BD SENSORS s.r.o.  
 Hradištská 817  
 CZ – 687 08 Buchlovice  
 Společnost BD SENSORS s.r.o. je certifikována společností TÜV SÜD Czech dle normy ISO 9001.

Tel.: +420 572 411 011  
 Fax: +420 572 411 497

www.bdsensors.cz  
 info@bdsensors.cz

